

About Product

IDEA generator sets are designed to be used as backup or continuous power supply. They are subjected to detailed load and performance tests in our production facilities in order to provide ideal performance and safe usage.



Power Output Values

Voltage	Standby Power (ESP)			Prime Power (PRP)		
	kVA	kW	Ampere	kVA	kW	Ampere
400/231	820 kVA	656 kW	1185	744 kVA	595 kW	1075

Standby Power (ESP) : This rating is for the supply of continuous electrical power at variable load , in the event of utility power failure. No overload is permitted.

Prime Power (PRP) : This rating is for the supply of continuous electrical power at variable load. There is no limitation on the annual hours in operation and 10% overload power can be supplied for 1 hour in 12.

Weight And Dimensions

Type	Width x Length x Height (mm)	Weight (kg)	Fuel Tank (Lt)	Sound dB(A) @7mt
Open	1650x3800x2000 mm	4390 kg	675 Lt	TBA
Soundproofed	1650x5100x2450 mm	5685 kg	675 Lt	TBA

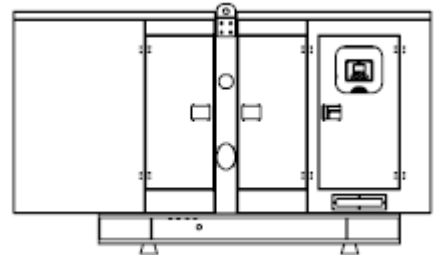
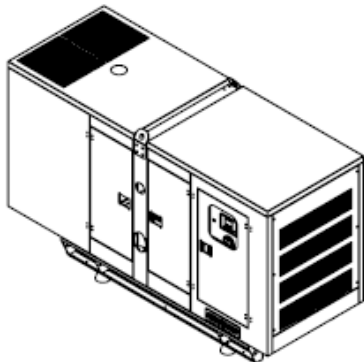

Engine

Frequency		50 Hz
Output Rating	kW	725
Manufacturer and Model		DAEWOO 12DWV-825
Fuel		Diesel
Injection		Direct
Aspiration		Turbo Charged & Intercooled
Cylinders		12
Bore and Stroke	mm	128 x 142
Displacement	lt	21,93
Cooling		Water
Engine Oil Specification		SAE 15W40
Compression Ratio		14.6:1
Engine Oil Capacity(Sump Only)	lt	41
Coolant Capacity (incl.radiator)	lt	123
Governor		Electronical
Air Filter		Dry element
FUEL CONSUMPTION		
100 % Load	lt/h	165,2
75 % Load	lt/h	118,2
50 % Load	lt/h	86,5
EXHAUST SYSTEM		
Maximum Temperature	°C	TBA
Exhaust Gas Flow	m ³ /min	TBA
Maximum Allowed Back Pressure	kPA	TBA
Exhaust Flange Size (Internal Dia.)	mm	99
AIR SYSTEM		
Intake Air Flow	m ³ /min	TBA
Total Cooling Air Flow	m ³ /min	TBA
STARTING SYSTEM		
Starter Motor	kW	9
Battery Capacity	Ah	2x120
Auxiliary Voltage	V	24

Alternator

Poles		4 pole
Winding Connections		Star
Insulation		Class H
Enclosure		IP23
Exciter System		Self regulating Brushless
Voltage Regulator		AVR
Steady State Voltage Regulation		± 1 %
Bearing		Single bearing sealed
Coupling		Flexible disc
Cooling		Direct drive centrifugal blower fan



Control Panel IDP300

The new IDP300 genset controller is a cost effective modular genset controller ready for internet monitoring through plug-in modules.

Its main advantages are multifunctionality, support for multiple topologies, harmonic analysis and detailed power measurements.

Software features are complete with easy firmware upgrade through USB port. The Windows based PC software allows monitoring and programming through USB, RS-485, RS-232, Ethernet and GPRS.

The Rainbow Scada web service allows monitoring and control of an unlimited number of gensets from a single central location.



Optional Equipments

Some Optional Equipment IDEA Provides with Generator Sets;

- Remote radiator applications,
- Automatic fuel filling system,
- Fuel tank, oil pan, instrument panel, alternator, coil heaters,
- Synchronization systems,
- Generator output fuse,
- Mains generator transfer switches,
- Seismic solutions,
- Remote monitoring
- Other requested solutions

Reference Standards

IDEA Generator Sets are CE approved and comply with the following standards;

- Power according to ISO 3046 and ISO 8528
- EN 12100 , EN 13857 , EN 60204
- 2006/42/CE Machinery Safety
- 2006/95/EC Low Voltage
- 2004/108/CE EMC
- Ambient reference conditions 1000 mbar, 25 °C, 30 % relative humidity ISO8528

All the information in this leaflet is intended for general purposes only. IDEA reserves the right to change the specifications without notice.

